

High Performance P-Clamps & Omega Clamps

Other Products



Luminus Series

[More details on back](#)



Smart Engineering
VICTREX® PEEK™ Polymer
Overmold Technology

Engineered for lean manufacturing, the High Performance P-Clamps and Omega Clamps were developed to replace and outperform traditional P-Clamps and Saddle Clamps. Featuring an overmold silicone cushion with VICTREX PEEK polymer, our clamps are completely non-conductive/non-corrosive, lightweight, and very durable.



High Performance Standoffs

[More details on back](#)

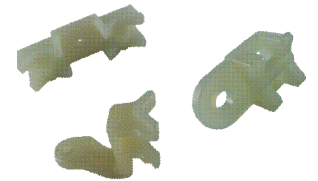

QuickClips

[More details on back](#)



Benefits at a Glance	
Smart Engineering	<p><u>Designed for Lean Manufacturing</u></p> <ul style="list-style-type: none"> Lock open & closed feature increases ease of installation One piece hinged design with overmolded grommet Easily recognizable labels makes inspection easy Uses standard 10-32 screws <p><u>Flexible Options</u></p> <ul style="list-style-type: none"> Fuel Resistant and High Temperature resistant rubbers available Dedicated to pressurized and unpressurized areas Compatible with tubes up to 2" in diameter Smaller envelope than existing metal P-Clamps Multiple Sizes Available <ul style="list-style-type: none"> P-Clamps: 15 Omega Clamps: 20
	<ul style="list-style-type: none"> Completely Non-Corrosive & Non-Conductive Improved Strength & Stability Lighter than Traditional P-Clamps by up to 40% High temperature resistance Withstands constant vibrations and shock loads
VICTREX PEEK Polymer	<ul style="list-style-type: none"> Completely Non-Corrosive & Non-Conductive Improved Strength & Stability Lighter than Traditional P-Clamps by up to 40% High temperature resistance Withstands constant vibrations and shock loads
Overmold Technology	<ul style="list-style-type: none"> Over 50 years experience in overmold technology Silicone or Fluorosilicone Cushion will not come off or slide off Allows broad range of variances in wire bundle diameters

Technical Specifications

High Performance P-Clamps

MATERIALS

Clamp Base	Polyetheretherketone (PEEK) per MIL-P-46183
Overmolding	Silicone Rubber per ASTM-D-2000

PERFORMANCE

Temperature Limits	Continuous: - 65°F to 350°F
	Excursions: up to 500°F
Flammability	UL94, V0; FAR25.853

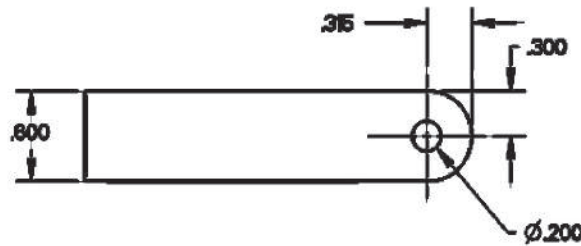
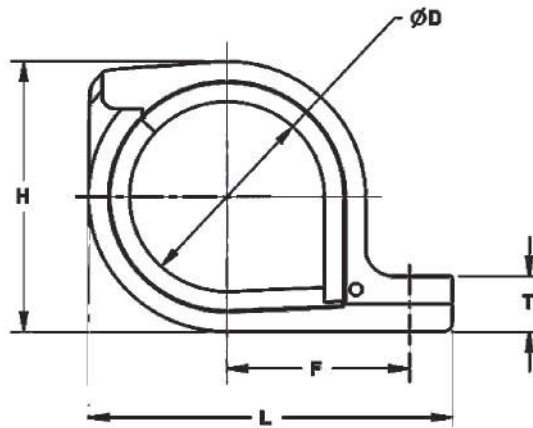

Application Example Securing Wire Bundle



Part No.	Size No.	Inner cushion diameter (ØD)		F		Length (L)		H		T		Weight	
		in	cm	in	cm	in	cm	in	cm	in	cm	ounces	grams
PCL150101	101	0.12	0.30	0.59	1.51	1.18	2.99	0.64	1.62	0.18	0.46	0.14	4.08
PCL150102	102	0.22	0.56	0.64	1.63	1.27	3.22	0.71	1.80	0.18	0.46	0.16	4.54
PCL150103	103	0.31	0.79	0.71	1.81	1.41	3.59	0.81	2.06	0.24	0.61	0.22	6.35
PCL150104	104	0.41	1.03	0.76	1.93	1.51	3.83	0.88	2.25	0.24	0.61	0.24	6.80
PCL150105	105	0.50	1.27	0.81	2.05	1.60	4.07	0.96	2.44	0.24	0.61	0.27	7.71
PCL150106	106	0.59	1.51	0.85	2.17	1.70	4.32	1.05	2.68	0.24	0.61	0.29	8.16
PCL150107	107	0.69	1.75	0.93	2.35	1.84	4.67	1.20	3.05	0.30	0.76	0.38	10.89
PCL150108	108	0.78	1.99	0.97	2.47	1.93	4.91	1.32	3.35	0.30	0.76	0.43	12.25
PCL150109	109	0.88	2.22	1.02	2.59	2.03	5.15	1.39	3.53	0.30	0.76	0.45	12.70
PCL150110	110	0.97	2.46	1.07	2.71	2.12	5.38	1.48	3.76	0.30	0.76	0.48	13.61
PCL150111	111	1.06	2.70	1.14	2.89	2.26	5.75	1.62	4.12	0.36	0.91	0.59	16.78
PCL150112	112	1.16	2.94	1.18	3.01	2.36	5.99	1.76	4.47	0.36	0.91	0.64	18.14
PCL150113	113	1.25	3.18	1.23	3.13	2.45	6.23	1.82	4.63	0.36	0.91	0.67	19.05
PCL150114	114	1.34	3.41	1.29	3.28	2.58	6.55	1.93	4.91	0.40	1.00	0.75	21.32
PCL150115	115	1.44	3.65	1.35	3.43	2.69	6.83	2.05	5.20	0.42	1.07	0.85	24.04

Technical Specifications

High Performance Omega Clamps

MATERIALS

Clamp Base	Polyetheretherketone (PEEK) per MIL-P-46183
Overmolding	Silicone Rubber per ASTM-D-2000
PERFORMANCE	
Temperature Limits	Continuous: - 65°F to 350°F
	Excursions: up 500°F
Flammability	UL94, V0; FAR25.853

Application Example Power Feeder Separator

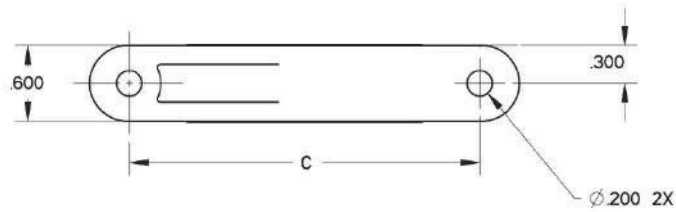
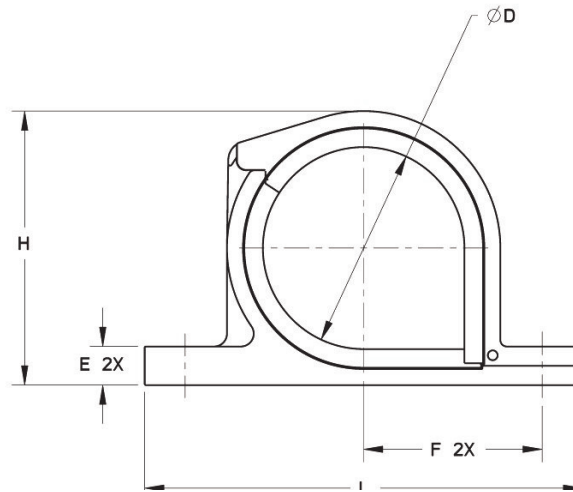
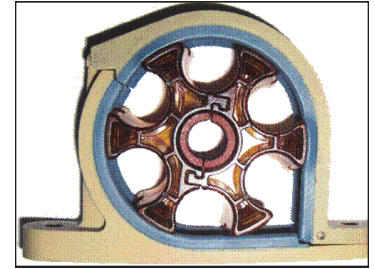

Part No.	Size No.	Inner cushion diameter (ØD)		F		Length (L)		H		E		C		Weight	
		in	cm	in	cm	in	cm	in	cm	in	cm	in	cm	ounces	grams
PCL250008	08	0.45	1.14	0.78	1.98	2.19	5.56	0.91	2.31	0.20	0.51	1.56	3.96	0.32	9.07
PCL250009	09	0.51	1.30	0.81	2.06	2.25	5.72	0.97	2.46	0.20	0.51	1.62	4.11	0.34	9.53
PCL250010	10	0.57	1.45	0.84	2.13	2.31	5.87	1.03	2.62	0.20	0.51	1.68	4.27	0.35	9.98
PCL250011	11	0.63	1.60	0.89	2.26	2.42	6.15	1.14	2.90	0.25	0.64	1.79	4.55	0.43	12.32
PCL250012	12	0.70	1.78	0.93	2.36	2.49	6.32	1.21	3.07	0.25	0.64	1.86	4.72	0.46	12.94
PCL250013	13	0.77	1.96	0.96	2.44	2.56	6.50	1.28	3.25	0.25	0.64	1.93	4.90	0.48	13.61
PCL250014	14	0.83	2.11	1.00	2.54	2.62	6.65	1.34	3.40	0.25	0.64	1.99	5.05	0.50	14.06
PCL250015	15	0.89	2.26	1.03	2.62	2.68	6.81	1.40	3.56	0.25	0.64	2.05	5.21	0.53	14.95
PCL250016	16	0.95	2.41	1.08	2.74	2.79	7.09	1.51	3.84	0.30	0.76	2.16	5.49	0.67	19.05
PCL250017	17	1.01	2.57	1.11	2.82	2.85	7.24	1.57	3.99	0.30	0.76	2.22	5.64	0.70	19.96
PCL250018	18	1.07	2.72	1.14	2.90	2.91	7.39	1.63	4.14	0.30	0.76	2.28	5.79	0.72	20.41
PCL250019	19	1.13	2.87	1.17	2.97	2.97	7.54	1.69	4.29	0.30	0.76	2.34	5.94	0.75	21.32
PCL250020	20	1.20	3.05	1.22	3.10	3.07	7.80	1.79	4.55	0.33	0.84	2.44	6.20	0.80	22.68
PCL250021	21	1.26	3.20	1.24	3.15	3.10	7.87	1.82	4.62	0.30	0.76	2.47	6.27	0.80	22.68
PCL250022	22	1.33	3.38	1.27	3.23	3.17	8.05	1.89	4.80	0.30	0.76	2.54	6.45	0.82	23.13
PCL250023	23	1.39	3.53	1.30	3.30	3.23	8.20	1.95	4.95	0.30	0.76	2.60	6.60	0.85	24.04
PCL250024	24	1.45	3.68	1.33	3.38	3.29	8.36	2.01	5.11	0.30	0.76	2.66	6.76	0.84	23.80
PCL250025	25	1.51	3.84	1.36	3.45	3.35	8.51	2.07	5.26	0.30	0.76	2.72	6.91	0.90	25.40
PCL250026	26	1.57	3.99	1.39	3.53	3.41	8.66	2.13	5.41	0.30	0.76	2.78	7.06	0.91	25.85
PCL250028	28	1.70	4.32	1.46	3.71	3.57	9.07	2.29	5.82	0.33	0.84	2.91	7.39	1.06	30.16
PCL250032	32	1.95	4.95	1.58	4.02	3.82	9.70	2.54	6.45	0.33	0.84	3.16	8.03	1.17	33.11

Additional Information

Other Products

Installation

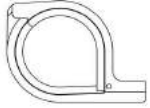

High Performance P-Clamp



A locking feature keeps P-Clamp Open

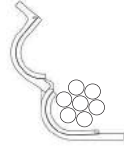

Wire bundle is inserted

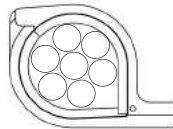

Second Locking Feature keeps P-Clamp Closed

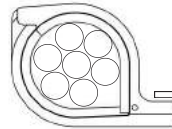

Screw inserted to complete installation

Mounting

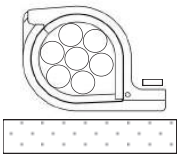

Surface Mounting

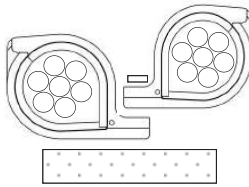

Stacked Surface Mounting

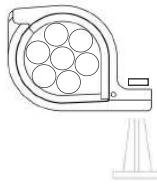

Standoff Mounting

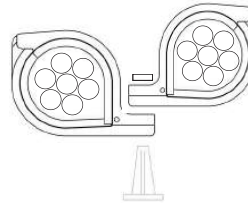

Stacked Standoff Mounting

Product Customization

The High Performance P-Clamps and Omega Clamps can be customized to your specific requirements.

Options include, but are not limited to:

- Fuel and High Temperature Applications
- Alternative Polymers and Rubbers Available
 - Specific Diameter Requirements
 - Accompanying Hardware

VICTREX PEEK polymers make Amphenol Pcd High Performance P-Clamps and Omega Clamps not only stronger, but lighter.

High performance, superior strength VICTREX PEEK polymer is designed to be chemical, radiation, smoke, and abrasion resistant. Able to withstand temperature as high as 500° F (260° C), VICTREX PEEK enables Amphenol Pcd to deliver High Performance P-Clamps and Omega Clamps that outperform traditional P-Clamps and Saddle Clamps.

VICTREX PEEK Polymers provide high-performance, lightweight solutions to a wide variety of markets, including:



- Aerospace
- Defense
- Industrial
- Medical
- Food Processing
- Automotive and Transport
- Electronics
- Semiconductor and Displays
- Industrial

For full technical information regarding VICTREX PEEK Polymer visit the Victrex website at www.victrex.com



Luminus Series

- Environmentally sealed
- Secure, "snap-locking" mechanism
- Multiple sizes and configurations
- Rugged and lightweight
- Easy to use and maintain
- Uses standard MIL-C-39029 and Stamped & Formed contacts



High Performance Standoffs

- VICTREX PEEK Polymer
- Non-Conductive; Non-Corrosive
- Lightweight



QuickClips

- Lightweight
- Customization available
- Strong and Durable

Amphenol Pcd

72 Cherry Hill Drive
Beverly, MA 01915 USA
Email: info@amphenolpcd.com
Tel: 978-624-3400

Amphenol Pcd

CONNECTING PEOPLE & TECHNOLOGY